

Hex Lag Screw

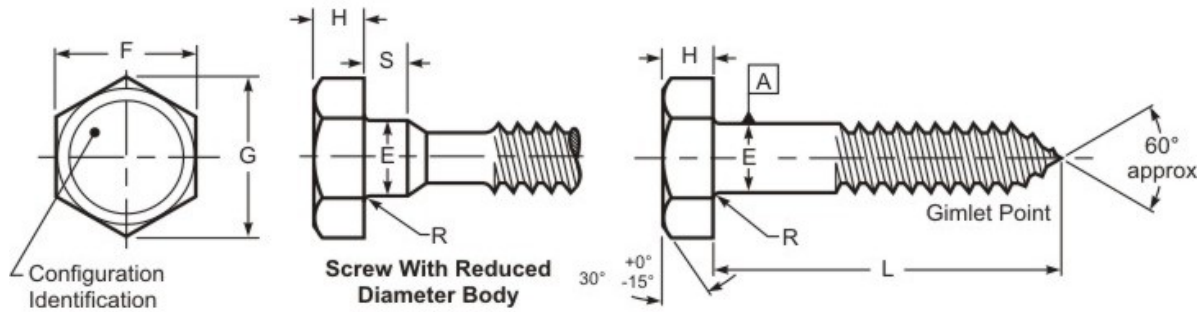

THREAD DATA		
Size: 1/4	Threads per in.: 10	Thread Class or Type: Lag
Major Diameter: 0.260 - 0.237	Minor Dia Max/Min.: 0.177 - 0.160	Standard: ASME B18.2.1-2012
Length: 3-1/2	Length Tolerance: ± 0.12	
DIMENSIONAL DATA		
Type: Hex Lag Screw	Standard: ASME B18.2.1-2012	Nominal Diameter: 0.25
E - Body Diameter : 0.260 - 0.237	F - Width Across Flats: 0.438 - 0.425	G - Width Across Corners: 0.505 - 0.484
R - Fillet Radius: 0.030 - 0.010	H - Head Height: 0.188 - 0.150	Point Type: Gimlet
PHYSICAL REQUIREMENTS		
Nominal: 0.25	Standard: ASTM A307-2014	Typical Materials: carbon steel: 1006 - 1022
Hardness: HRB 69 - 100	Tensile Load, Min. (lbf): 1533 ref. (min. minor dia X 60 ksi)	Calculated Shear Load-BODY (ref.)(lbf): 920
Calculated Shear Load-THREADS (ref.)(lbf): 766	Straightness Factor: 0.021	
FINISH DATA		
Finish: Zinc & Clear, non-hexavalent/Cr(VI) free - .0001"/ 3 μ m	K factor (ref. DIN 946): 0.22	Standard: ASTM F1941/F1941M-2016, Fe/Zn 3AN

¹ These torque values are based on K factors determined using DIN 946, tightening tension of 75% of the yield strength, and the calculation formula $T=KDP$. These values are advisory only. The torque for assembling critical joints should be determined and/or verified through actual experimentation by the user. The IFI is not responsible for any losses or claims resulting from the use of these values.² Calculated Pretension is equal to 75% of the bolt's yield strength achieved when using the indicated Tightening Torque.

